



萬達光電科技股份有限公司
HIGGSTEC INC.

PRODUCT SPECIFICATIONS

產品規範書

Customer (客戶) :

Model (型式) :

Mode (種類) : Five-wire Analog Touch Panel

Date (日期) : JUN. 30, 2008

Version (版本) : C01.00

Customer Approval

客戶簽認

HIGGSTEC INCORPORATED

8 F., No. 609, Wan Shou Rd., Sec. 1,
Kweishan, Taoyuan Hsien 33350,
Taiwan.

TEL: 886-2-8209-9696

FAX: 886-2-8200-3030

E-mail: info@higgstec.com.tw

Approve 確認	Review 審訂	Preparation 製表
Henry	Andy	Young

TABLE OF CONTENTS

目 錄

00. Specification Revision Record [規格變更記錄].....	01
00. Dimension Drawing [尺寸圖].....	02
01. Scope [範圍].....	03
02. Features [特性].....	03
03. General Specification [一般規格].....	03
04. Environmental Characteristics [環境特性].....	03
05. Optical Characteristics [光學特性].....	04
06. Electrical Characteristics [電子特性].....	04
07. Mechanical Characteristics [機械特性].....	05
08. Reliability [可靠度].....	05
09. Durability [耐久性].....	05
10. Inspection Methods [檢查方法].....	06
11. Appearance Inspection [外觀檢查].....	07
12. Attention for Mounting [裝機注意事項].....	08
13. Warranty [保固].....	09
14. Appendices [附註].....	09
Appearance Specification [外觀檢查規格].....	11
15. Caution [注意事項].....	10



01. Scope

[範圍]

The specification is for Five-Wire Analog Resistive touch panel.

[此規格適用於五線-類比電阻式觸控螢幕]

02. Features

[特性]

Item [項目]		Specifications [規格]
(1)	Type [型式]	Five-Wire Analog Resistive [五線-類比電阻式]
(2)	Input Mode [操作模式]	Stylus or Finger [筆觸或手觸]
(3)	Cable [連結線]	Shielded Polyester Flat Flexible Cable [以 FFC 連結]

03. General Specification

[一般規格]

Item [項目]		Specifications [規格]
(1)	Frame Size [外框尺寸]	
(2)	View Area [可視區]	
(3)	Active Area [動作區]	
(4)	Total Thickness [總厚度]	
(5)	Tail Length [出線長度]	

04. Environmental Characteristics

[環境特性]

Item [項目]		Specifications [規格]	
		Temperature [溫度]	Humidity [濕度] (Non Condensing) [未凝結]
(1)	Operation [操作]	-30°C ~ +85°C	20%RH ~ 90%RH (See Figure 4-1)
(2)	Storage [儲存]	-40°C ~ +90°C	10%RH ~ 90%RH (See Figure 4-1)

Note: All terms under 1 atmosphere.

[註:於正常的 1 大氣壓下]

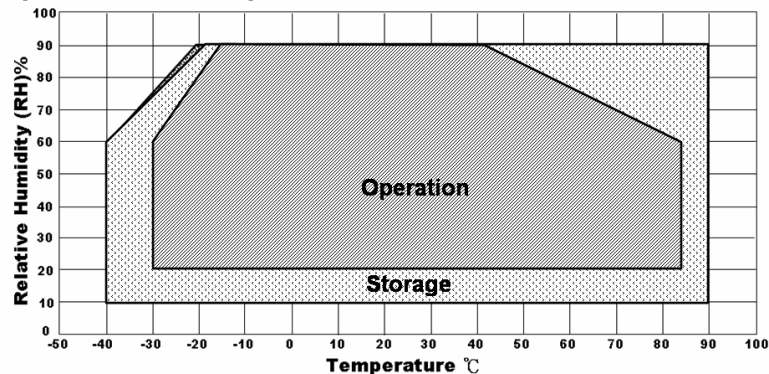

Figure 4-1



05. Optical Characteristics
[光學特性]

Item [項目]		Specifications [規格]
(1)	Transparency [透光度]	80% ± 2% (clear type measured by BYK-Gardner at 550nm)
(2)	Haze [霧化度]	Antiglare Finish: 9.5% ± 2%

06. Electrical Characteristics
[電子特性]

Item [項目]		Specifications [規格]
(1)	Loop Resistance [迴路阻抗]	X: 20~500Ω, Y: 20~500Ω (See Figure 6-1)
(2)	Linearity [線性]	$X \leq 1.5\%$, $Y \leq 1.5\%$ (See Figure 10-2)
(3)	Chattering [作動時間]	$\leq 15\text{ms}$
(4)	Insulation [絕緣阻抗]	$\geq 20\text{M}\Omega/25\text{V(DC)}$
(5)	Endurance [耐電壓]	No acting damage at DC50V/60sec.

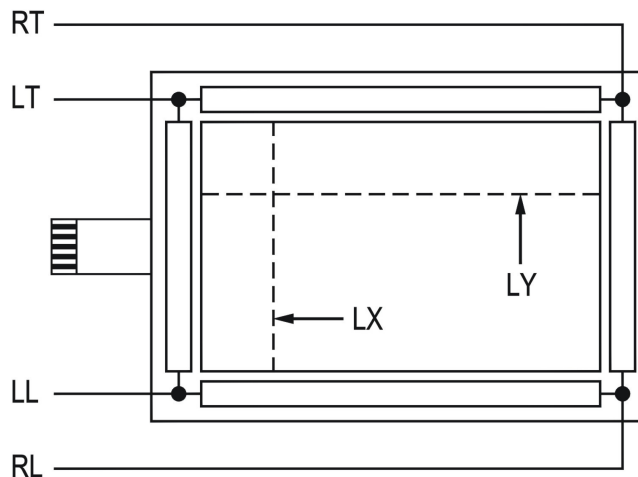

Figure 6-1 Loop Resistance X = short RT and RL , short LT and LL , measure the resistance between RT and LT
Loop Resistance Y = short RT and LT , short RL and LL , measure the resistance between RT and RL

07. Mechanical Characteristics
[機械特性]

Item [項目]		Specification [規格]	Condition [條件]
Panel [螢幕區]	Operating Force [作動力]	Stylus=R0.8 [筆式=R0.8]	≤ 50g
	Impact [撞擊]	13.0 φ DIA. Steel Ball/9g Height=30cm [13 φ /9g 鋼球 高度=30cm]	1 time, no damage [Impact at center area] [中央區域撞擊 1 次,不能破損]
	Static Load [靜態承重]	500g within 6cm ² area for 30sec [500g 置於 6cm ² 內, 30 秒]	Satisfy(1) of Item 7 and (1), (2),(4) of Item 6 [符合 7 項目(1)及 6 項目(1),(2),(4)]
	Hardness [硬度]	3H pencil, pressure 1N/45° [鉛筆 3H,壓力 1N/45°(JIS K-5400)]	≥ 3H
FFC [連結線]	Peeling [剝離]	800g by vertical 90° [800g, 垂直 90°]	Satisfy (1) of Item 6 [符合 6 項目(1)]
	Bending [繞折]	135° 10 times left & right [135°角,左右來回 10 次]	Satisfy (1) of Item 6 [符合 6 項目(1)]

08. Reliability
[可靠度]

Item [項目]		Specification [規格]	Condition [條件]
Panel [螢幕區]	High Temperature /Humidity [恆溫恆濕]	70°C /80%RH, 500 hrs, allow panel stays in normal environment for 4 hrs [70°C /80%RH, 500 小時, 回常溫 4 小時後始可測試]	Reliability test may cause the film puffed yet the electric characteristic stays intact. (1), (2) of Item 5; (1), (4) of Item 6; (2) of item 6 satisfies X ≤ 2.5%, Y ≤ 3.5% [符合 5 項目(1)、(2)及 6 項目(1)、(4); 6 項目(2)符合 X ≤ 2.5%, Y ≤ 3.5%]
	High temperature [高溫]	70°C /500 hrs allow panel stays in normal environment for 4 hrs [70°C /500 小時, 回常溫 4 小時後始可測試]	
	Low temperature [低溫]	-40°C /500 hrs allow panel stays in normal environment for 4 hrs [-40°C /500 小時, 回常溫 4 小時後始可測試]	
	Thermal Cycle [冷熱循環]	-40°C ~80°C [60 min./cycle] *100 cycles allow panel stays in normal environment for 4 hrs [-40°C ~80°C, 每循環 60 分鐘, 共 100 次循環, 回常溫 4 小時後始可測試]	

09. Durability
[耐久性]

Item [項目]		Specification [規格]	Condition [條件]
Panel [螢幕區]	Knock Test [觸擊測試]	35,000,000 times [3500 萬次]	Satisfy (1), (2) of Item 5; (1), (4) of Item 6; (2) of item 6 satisfies X ≤ 3.0%, Y ≤ 5.0% [符合 5 項目(1)、(2)及 6 項目(1)、(4); 6 項目(2)符合 X ≤ 2.5%, Y ≤ 3.5%]



10. Inspection Methods :

[檢查方法]

(1) Linearity [線性測試條件]

Step 1: Short RT and RL(or short RL and LL).

Step 2: apply voltage DC 5V.

Step 3: short LT and LL (or short RT and LT).

Step 4: apply grounding.

Step 5: draw points along Lx and Ly at 5.0mm intervals within pattern area and detect the voltage at SG.

Step 6: measure the voltage differences between RT and LT(or RT and RL) (Fig 10-1) (Fig 10-2)

[將 RT, RL 短路(或 RL, LL 短路)並接上 5V 的直流電, 另外將 LT, LL 短路(或 RT, LT 短路)並接上接地線 0V, 以 5.0mm 的間隔, 利用手寫筆(stylus)劃直線(如圖 2 中 LX 和 LY), 並量測 SG 的電壓, 量測並計算 RT 與 LT 間的電位差(或 RT 與 RL

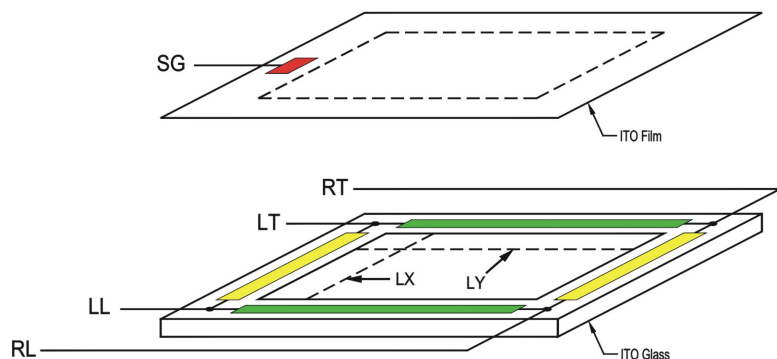

Figure 10-1

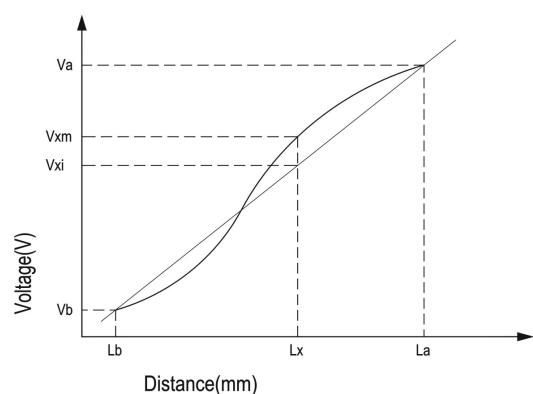
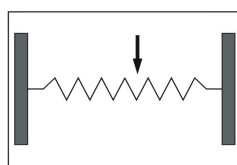

Figure 10-2

$$\ast \text{ Linearity: } [| V_{xm} - V_{xi} |] / (V_a - V_b) \times 100\%$$

(2) Specification [規範]

Linearity must meet the electrical characteristic specified in Item 6

[線性必須符合 6 項目的電性規範]

11. Appearance Inspection

[外觀檢查]

(1) A 17W fluorescent luminant lamp is used for appearance inspection. Detail settings are shown in Figures 11-1 and 11-2.

[(1) 檢測始用之燈光為一盞 17W 白熾燈光，並於面板後側或上側照射，檢測時須放置在離眼睛 30cm 處(Figure11-1), (Figure11-2)]

(2) Minor impurities outside viewing area are acceptable unless their existence affect electrical functions.

[(2) 只要不影響電器功能性，可視區外之外觀瑕疵是可以被允許的]

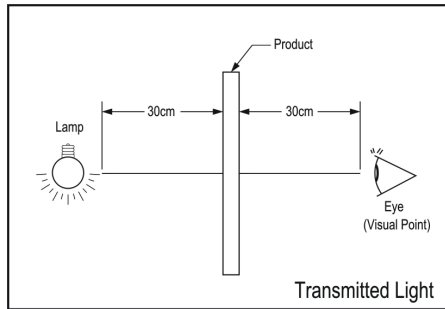

Figure 11-1

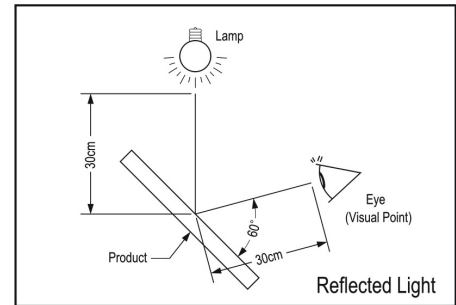

Figure 11-2

(3) Glass Flaw [玻璃瑕疵]

Item [項目]	Picture [圖示]	Specification [規格]
Corner Flaw [角瑕疵]		$X \leq 3.0\text{mm}$ $Y \leq 3.0\text{mm}$ $Z \leq T$
Edge Flaw [邊緣瑕疵]		$X \leq 3.0\text{mm}$ $Y \leq 3.0\text{mm}$ $Z \leq T$
Progressive Flaw [裂縫瑕疵]		Not allowed [不允許]

Note: T=Glass thickness

(4) Please refer to Appendix I : Appearance Specification.

[(4)外觀規格請詳見(附註 1)]



12. Attention for Mounting

[裝機注意事項]

- (1) The gasket support of touch panel must allocate outside of Viewable Area. Reserve enough clearance between panel surface and enclosure for normal panel operation.

To avoid pressing error, please retain enough space between surface panel and Bezel.

[請將固定觸控屏用的支撐體(support)設計於可視區(Viewable area)之外。為避免不小心碰到觸控屏而產生動作，請預留空間於面板與機體外殼之間]

- (2) Bezel opening must not touch Viewable Area, Bezel opening must be designed between Viewable Area and Active Area.

[外殼內緣(Bezel opening)應設計於可視區及動作區之間，並且不得碰到可視區]

- (3) We recommend elastic material support.

[建議使用彈性物質製成的支撐體]

- (4) Due to the conductive characteristic of the panel backside, prevent metal contact after mounting.

[觸控屏面板背面具導電性質，安裝後請避免與其他金屬物質接觸]

- (5) Proper grounding of controller at all times assure normal operation.

[觸控屏正常的作動有賴於控制器確實的電源接地]

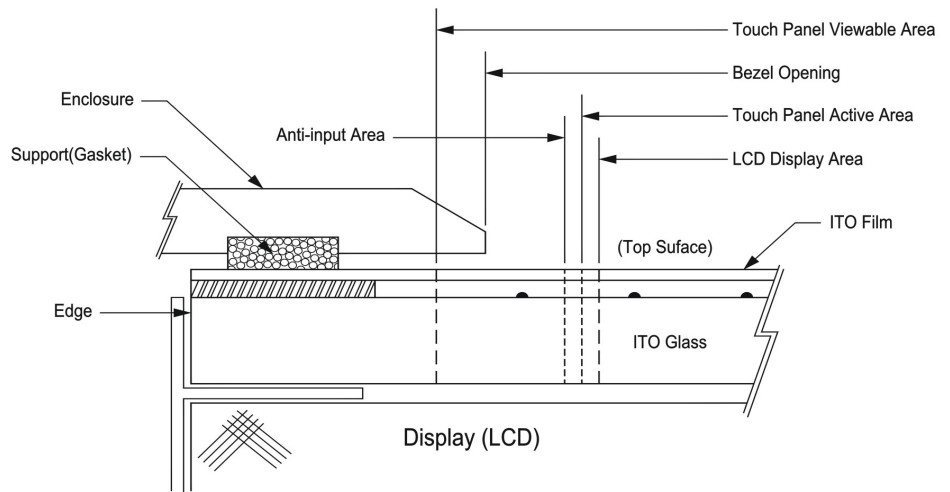

Figure 12-1

13. Warranty

[保固]

HIGGESTEC comes with a 2-year limited warranty on all Five-Wire Analog products.

[除了下列 3 點所述外，萬達光電所生產製造的產品保固期限為 2 年]

Warranty does not cover the following situations:

1. Damages caused by improper handling from clients, including shipping, installation and integration.

[在客戶的製程或運輸中,因客戶自身疏忽所造成對產品的傷害及破損]

2. Damages caused by either natural or human factors after receiving the products.

[在客戶收到萬達光電之產品後,因為天災人禍所造成的傷害及破損]

3. Damage caused by self-repairs, modifications or disassembling of the product.

[自行變更、維修、拆卸產品所造成的傷害及破損]

14. Appendix

[附註]

Item [項目]	Content [內容]	Page number [頁數]
Appendix I [附註一]	Appearance Specification [外觀檢查規格]	1 page

15. Caution

[注意事項]

Storage [儲存]	<p>Store panel under the temperature and humidity range pre-specified. Direct sunlight exposure or piling should be avoided.</p> <p>[儲存要注意溫/濕度條件，且不可直接暴露於陽光下，或堆疊造成直接加壓面板]</p>
Unpack [拆裝]	<p>Unpack the box with the printed red arrow pointing up.</p> <p>[注意檢查包裝箱之箭頭方向，以避免損壞]</p>
Handling [握持]	<p>(1) Use clean sacks or glove to prevent fingerprints and/or stains left on the panel. Extra attention and carefulness should be taken while handling the glass edge.</p> <p>[配戴清潔的指套、手套、口罩，以避免造成指紋、髒污或不小心被玻璃邊緣割傷]</p> <p>(2) Avoid touching the viewing area before installation/integration.</p> <p>[安裝組合時，避免接觸可視區]</p> <p>(3) Holding the panel instead of the tail at all time.</p> <p>[拿取面板時，不可直接拿取 tail 部份，易造成結合度及信賴性問題]</p>
Cleaning [清潔]	<p>(1) Use neutral detergent or isopropyl alcohol on a clean soft cloth to clean the panel surface.</p> <p>[使用乾淨且柔軟的布，沾中性清潔劑或酒精進行清潔]</p> <p>(2) Prevent using any kind of chemical solvent, acidic or alkali solution.</p> <p>[不能使用化學溶劑或酸鹼液進行清潔]</p>
Installing and Assembling [組合與裝配]	<p>(1) Excessive force or strain to the panel or tail is prohibited.</p> <p>[注意避免加壓或拉扯面板及 tail]</p> <p>(2) Retain at least 0.3 mm clearance between panel and display module.</p> <p>[最少保留 0.3mm 的空間於面板及顯示器之間]</p> <p>(3) Gasket or cushion pads around the edge of the panel may segregate water and/or dust contamination.</p> <p>[在設計機構時，注意四周邊緣需有緩衝墊，以避免滲水或聚集灰塵]</p>
Operating [操作]	<p>(1) Touch the panel with your finger or stylus only to assure normal operation. Any sharp edged or hard objects are prohibited.</p> <p>[應用手指，不能使用尖銳、堅硬的物體書寫輸入]</p> <p>(2) Operate the panel in a steady environment. Abrupt variation on temperature and humidity may cause malfunction of the panel.</p> <p>[急遽的溫/濕度變化會有結露現象，易造成面板功能失效，所以穩定的環境條件是必要的]</p>
Others [其他]	<p>(1) Keep the panel surface clean. Prevent any kind of adhesive applied on the surface.</p> <p>[請保持表面清潔，不要貼膠帶於面板上]</p> <p>(2) Avoid high voltage and/or static charge.</p> <p>[避免高壓與靜電]</p> <p>(3) Abon Touchsystems has the right to change the materials and/or specifications.</p> <p>[萬達光電保有變更規格及材料的權利]</p>



Appearance Specification

【Appendix I】

Item [項目]	Specification [規格] Unit: mm
Particle [顆粒異物]	(1) $D \leq 0.25 \rightarrow \text{OK}$ (2) $0.25 < D \leq 0.4$ (each area contains ≤ 3 , total ≤ 5) $\rightarrow \text{OK}$ (3) $D > 0.4 \rightarrow \text{NG}$
Linear Object [線狀異物]	(1) $W \leq 0.05 \rightarrow \text{OK}$ (2) $0.05 < W \leq 0.1$ and $L \leq 5.0$, total $\leq 3 \rightarrow \text{OK}$ (3) $W > 0.1 \rightarrow \text{NG}$ Remark: the particle will be ignored when it is removable by cleaning.
Scratch [刮傷]	(1) $W \leq 0.025 \rightarrow \text{OK}$ (2) $0.025 < W \leq 0.05$ and $L \leq 12.0$, total $\leq 5 \rightarrow \text{OK}$ (3) $0.05 < W \leq 0.1$ and $L \leq 6$, total $\leq 5 \rightarrow \text{OK}$ (4) $W > 0.1 \rightarrow \text{NG}$
<p>< Remark > [備註欄]</p> <p>1. D=Diameter=直徑 2. W=Width=寬度 3. L=Length=長度 4. Each area contains=20 ϕ =區域範圍 20 ϕ</p>	

